

# MDK Slimbright

High Value Interior Illumination

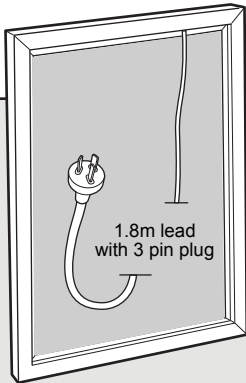

REAR VIEW

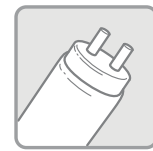
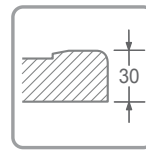
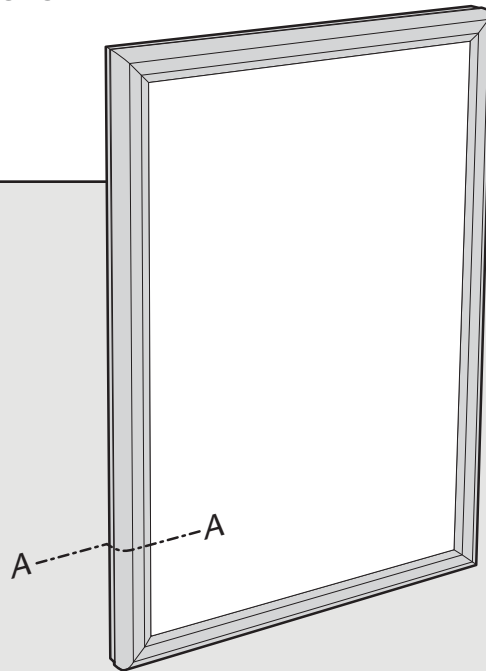

FRONT VIEW

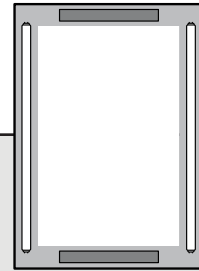

Shows position of ballasts and tubes in standard box

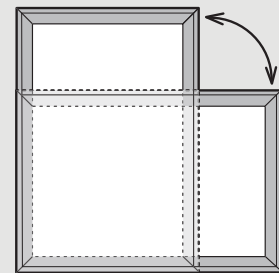

Suitable for portrait or Landscape orientation

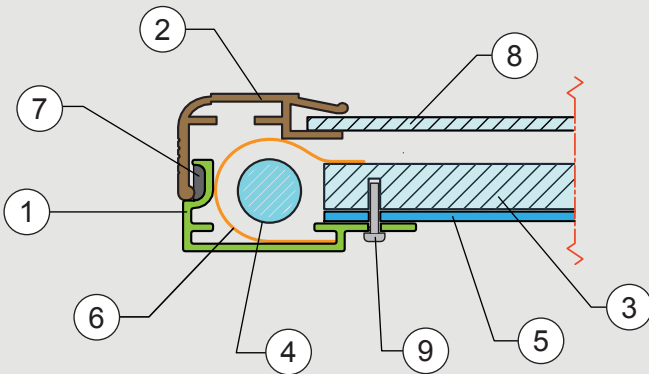

SECTION AA

NO.	PART	MATERIAL	QTY
1	FRAME PROFILE	EXTRUDED ALUMINIUM	4
2	FRONT FRAME PROFILE	EXTRUDED ALUMINIUM	4
3	ILLUMINATED PANEL	9MM ACRYLIC	1
4	T4 FLUORESCENT TUBE	GLASS	2
5	BACKING SHEET	3MM POLYPROPYLENE	1
6	DIFFUSION SHEET	0.1MM POLYPROPYLENE	2
7	INTERFERENCE STRIP	POLYURETHANE	4
8	FACE SHEET	3MM ACRYLIC	1
9	PAN HEAD SCREW	M4 X 10	18

## Unit and Artwork Dimensions

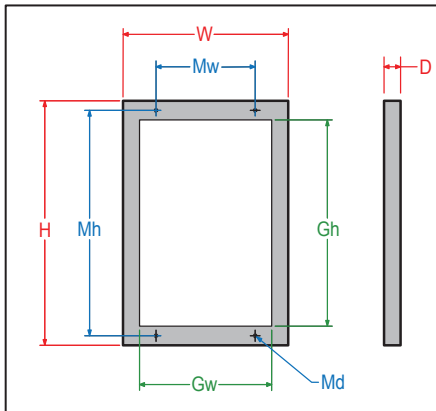

Model	Unit size			Graphic area		Mount holes			Poster size	
	H	W	D	Gh	Gw	Mh	Mw	Md		
MDK - A0	1234	886	30	1174	826	1204	726	8	1189	841
MDK - A1	886	639	30	831	584	856	479	8	841	594
MDK - A2	639	465	30	584	410	609	305	8	594	420
MDK - A3	465	342	30	410	287	435	182	8	420	297
MDK - 1	1045	655	30	985	605	1015	495	8	991	611
MDK - 2	757	555	30	700	500	727	395	8	710	510
MDK - 3	555	555	30	495	495	525	395	8	501	501

Custom sizes and specifications readily facilitated

## Technical Performance Statistics

Model	Average Brightness	Lighting and Ballasts	Annual Power Consumption*	Average Bulb Life **	Weight (kg)
MDK - A0	3440	T4 30W x 2 = 60W	A\$39.42	3 yrs	21.9
MDK - A1	3230	T4 28W x 2 = 56W	A\$36.79	3 yrs	10.7
MDK - A2	3330	T4 20W x 2 = 40W	A\$26.28	3 yrs	7.0
MDK - A3	3190	T4 12W x 2 = 24W	A\$15.77	3 yrs	3.1
MDK - 1	3210	T4 28W x 2 = 56W	A\$36.79	3 yrs	6
MDK - 2	3170	T4 22W x 2 = 44W	A\$28.91	3 yrs	6.5
MDK - 3	3100	T4 20W x 2 = 40W	A\$26.28	3 yrs	7

\* Annual power consumption based on a 12 hour operational day at \$0.15/Kw (Australian average in 2006)

\*\* Bulb life is calculated based on a 12 hour operational day



© Copyright 2007 and Intellectual Property reserved. CONFIDENTIAL: Not to be used for any purpose without the express written authorisation of CS & G Signage Group Pty. Limited.

All dimensions and information are intended as a guide only and are subject to change without notice.